



TADANO

GR-750XL-2

68.0 Metric Tons (75 Ton) Capacity

HYDRAULIC ROUGH TERRAIN CRANE

DIMENSIONS

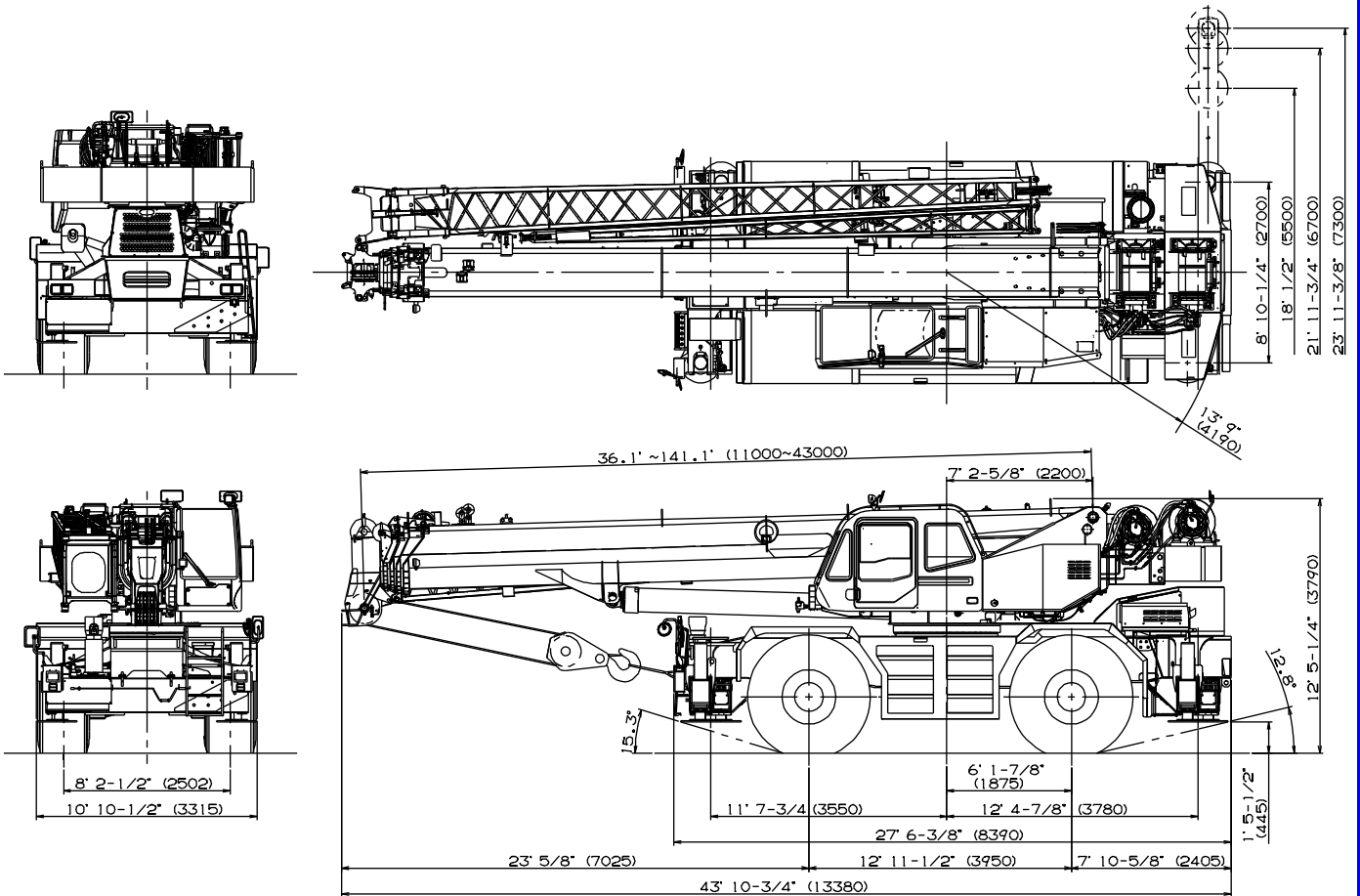

Note : Dimension is with boom angle at -1.6 degree.

() Reference dimensions in feet.

GENERAL DIMENSIONS (29.5 - 25 Tires)

	Meters	Feet
Turning radius		
4 wheel steer	6.8	22' 4"
2 wheel steer	11.9	39' 1"

Specifications are subject to change without notice.

CRANE SPECIFICATIONS

BOOM

Five section full power synchronized telescoping boom, 11.0m~43.0m (36.1'~141.1'), of round box construction with six sheaves, 0.44m (17-5/16") root diameter, at boom head. The synchronization system consists of two telescope cylinders, an extension cable and retraction cable. Hydraulic cylinder fitted with holding valve. Two easily removable wire rope guards, rope dead end provided on both sides of boom head. Boom telescope sections are supported by wear pads both vertically and horizontally. Extension speed 32.0m(105') in 128 seconds.

BOOM ELEVATION - By a double acting hydraulic cylinder with holding valve. Elevation -1.6°~80.3°, combination controls for hand or foot operation. Boom angle indicator. Automatic speed reduction and slow stop function. Boom raising speed 20° to 60° in 46 seconds.

JIB - two stage bi-fold lattice type, 3.5°, 25° or 45° offset (tilt type). Single sheave, 0.396m(15-5/8") root diameter, at the head of both jib sections, which stows alongside base boom section. Jib length is 10.1m(33.2') or 17.7m(58.1'). Assistant cylinders for mounting and stowing, controlled at right side of superstructure. Self stowing jib mounting pins.

AUXILIARY LIFTING SHEAVE (SINGLE TOP)
Single sheave, 0.396m(15-5/8") root diameter. Mounted to main boom head for single line work (stowable).

ANTI-TWO BLOCK - Pendant type over-winding cut out device with audio-visual (FAILURE lamp/BUZZER) warning system.

SWING

Hydraulic axial piston motor through planetary swing speed reducer. Continuous 360° full circle swing on ball bearing turn table at 2.4min⁻¹{rpm}. Equipped with manually locked/released swing brake. A 360° positive swing lock for pick and carry and travel modes, manually engaged in cab. Twin swing system: Free swing or lock swing controlled by selector switch on front console.

HOIST

MAIN HOIST - Variable speed type with grooved drum driven by hydraulic axial piston motor through speed reducer. Power load lowering and raising. Equipped with automatic brake (neutral brake) and counterbalance valve. Controlled independently of auxiliary hoist. Equipped with cable follower and drum rotation indicator.

DRUM - 0.40m(Grooved 15-3/4") root diameter x 0.599m(23-9/16") wide. Wire rope: 235m of 19mm diameter rope (771' of 3/4"). Drum capacity: 327.5m(1,074') 7 layers. Maximum single line pull: 1st layer 6,880kg(15,200 lbs). Maximum permissible line pull wire strength:7,085kg(15,600 lbs).

AUXILIARY HOIST - Variable speed type with grooved drum driven by hydraulic axial piston motor through speed reducer. Power load lowering and raising. Equipped with automatic brake (neutral brake) and counterbalance valve. Controlled independently of main hoist. Equipped with cable follower and drum rotation indicator.

DRUM - Grooved 0.40m(15-3/4") root diameter x 0.599m (23-9/16") wide. Wire rope: 133m of 19mm diameter rope (436' of 3/4"). Drum capacity: 327.5m(1,074') 7 layers. Maximum single line pull: 1st layer 6,880kg(15,200 lbs). Maximum permissible line pull wire strength:7,085kg(15,600 lbs).

WIRE ROPE - Warrington seal wire, extra improved plow steel, preformed, independent wire rope core, right regular lay. 19 mm(3/4") 6X31 class

HOOK BLOCKS

68.0 metric ton (75 Ton) - 7 sheaves with swivel hook and safety latch, for 19mm(3/4") wire rope.(OPTIONAL)
35.0 metric ton (38.6 Ton) - 3 sheaves with swivel hook and safety latch, for 19mm(3/4") wire rope.(OPTIONAL)
5.6 metric ton (6.2 Ton) - Weighted hook with swivel and safety latch, for 19mm(3/4") wire rope.

HYDRAULIC SYSTEM

PUMPS - Two variable piston pumps for crane functions. Tandem gear pump for steering, swing and optional equipment. Powered by carrier engine. Pump disconnect for crane is engaged/ disengaged by rotary switch from operator's cab.

CONTROL VALVES - Multiple valves actuated by pilot pressure with integral pressure relief valves.

RESERVOIR - 840 liters.(222 gallon) capacity. External sight level gauge.

FILTRATION - BETA10=10 return filter, full flow with bypass protection, located inside of hydraulic reservoir. Accessible for easy replacement.

OIL COOLER - Air cooled fan type.

CAB AND CONTROLS

Both crane and drive operations can be performed from one cab mounted on rotating superstructure.

Left side, 1 man type, steel construction with sliding door access and safety glass windows opening at side. Door window is powered control. Windshield glass window and roof glass window are shatter-resistant. Tilt-telescoping steering wheel. Adjustable control lever stands for swing, boom hoist, boom telescoping, auxiliary hoist and main hoist. Control lever stands can change neutral positions and tilt for easy access to cab. 3 way adjustable operator's seat with high back, headrest and armrest. Engine throttle knob. Foot operated controls: boom elevating boom telescoping, service brake and engine throttle. Hot water cab heater and air conditioning.

Dash-mounted engine start/stop, monitor lamps, cigarette lighter, drive selector switch, parking brake switch, steering mode select switch, power window switch, pump engaged/ disengaged switch, swing brake switch, telescoping/auxiliary hoist select switch, outrigger controls, free swing / lock swing selector switch, eco mode switch, and ashtray.

Instruments - Torque converter oil temperature, engine water temperature, air pressure, fuel, speedometer, tachometer, hour meter and odometer / tripmeter. Hydraulic oil pressure is monitored and displayed on the AML-C display panel.

Tadano electronic LOAD MOMENT INDICATOR system (AML-C) including:

- Control lever lockout function with audible and visual pre-warning
- Boom position indicator
- Outrigger state indicator
- Boom angle / boom length / jib offset angle / jib length / load radius / rated lifting capacities / actual loads read out
- Ratio of actual load moment to rated load moment indication
- Automatic Speed Reduction and Slow Stop function on boom elevation and swing
- Working condition register switch
- Load radius / boom angle / tip height / swing range preset function
- External warning lamp
- Tare function
- Fuel consumption monitor
- Main hoist / auxiliary hoist select
- Drum rotation indicator (audible and visible type) main and auxiliary hoist

TADANO AML-C monitors outrigger extended length and automatically programs the corresponding "RATED LIFTING CAPACITIES" table

Operator's right hand console includes transmission gear selector and sight level bubble. Upper console includes working light switch, roof washer and wiper switch emergency outrigger set up key switch, jib equipped/removed select switch, eco mode switch, boom emergency telescoping switch (2nd and 3rd· 4th· top) and air conditioning control switch. Swing lock lever.

NOTE: Each crane motion speed is based on unladen conditions.

CARRIER SPECIFICATIONS

TYPE - Rear engine, left hand steering, driving axle 2-way selected type by manual switch, 4x2 front drive, 4x4 front and rear drive.

FRAME - High tensile steel, all welded mono-box construction.

TRANSMISSION - Electronically controlled full automatic transmission. Torque converter driving full powershift with driving axle selector. 6 forward and 2 reverse speeds, constant mesh.

- 3 speeds - high range - 2 wheel drive; 4 wheel drive
- 3 speeds - low range - 4 wheel drive

TRAVEL SPEED - 36 km/h (22 mph)

AXLE - Front: Full floating type, steering and driving axle with planetary reduction. Rear: Full floating type, steering and driving axle with planetary reduction and non-spin rear differential.

STEERING- Hydraulic power steering controlled by steering wheel. Four steering modes available: 2 wheel front, 2 wheel rear, 4 wheel coordinated and 4 wheel crab .

SUSPENSION - Front: Rigid mounted to frame. Rear: Pivot mounted with hydraulic lockout device.

BRAKE SYSTEMS - Service: Air over hydraulic disc brakes on all 4 wheels. Parking/Emergency: Spring applied-air released brake acting on input shaft of front axle. Auxiliary: Electro-pneumatic operated exhaust brake.

TIRES - 29.5-25 22PR(OR) Air pressure:420 kPa (60 psi) or 29.5-25 28PR(OR) Air pressure:450 kPa (64 psi)

OUTRIGGERS - Four hydraulic, beam and jack outriggers. Vertical jack cylinders equipped with integral holding valve. Each outrigger beam and jack is controlled independently from cab. Beams extend to 7.3 m (23' 11-3/8") center-line and retract to within 3.315 m (10' 10-1/2") overall width with floats. Outrigger jack floats are attached thus eliminating the need of manually attaching and detaching them. Controls and sight bubble located in superstructure cab. Four outrigger extension lengths are provided with corresponding "RATED LIFTING CAPACITIES" for crane duty in confined areas.

- Min. Extension 2.7m(8' 10-1/4") center to center
- Mid. Extension 5.5m(18' 1/2") center to center
- Mid. Extension 6.7m(21' 11-3/4") center to center
- Max. Extension 7.3m(23' 11-3/8") center to center
- Float size(Diameter) 0.6m (1' 11- 5/8")

ENGINE

Model	Mitsubishi 6M60-TLA3B (Tier2)
Type	Direct injection diesel
No. of cylinders	6
Combustion	4 cycle, turbo charged and after cooled
BoreXStroke, mm(in.)	118X115 (4.646 X 4.528)
Displacement, liters (cu.in)	7.54 (460)
Air inlet heater	24 volt preheat
Air cleaner	Dry type, replaceable element
Oil filter	Full flow with replaceable element
Fuel filter	Full flow with replaceable element
Fuel tank, liters(gal.)	300 (79.2), right side of carrier
Cooling	Liquid pressurized, recirculating by-pass

Radiator	Fin and tube core, thermostat controlled
Fan, mm(in.)	Suction type, 6-blade, 600 (23.6) dia.
Starting	24 volt
Charging	24 volt system, negative ground
Battery	2-120 amp. Hour
Compressor, air, l /min(CFM)	830 (29) at 2,600rpm
Output, Max. kW(HP)	Gross 200 (267) at 2,600rpm
Torque, Max. Nm(ft-lb)	785 (579) at 1,400rpm
Capacity, liters(gal.)	
Cooling water	13 (3.4)
Lubrication	13-15 (3.4-4.0)
Fuel	300 (79.2)

STANDARD EQUIPMENT

- Five section full power partially synchronized boom 36.1'~141.1' (11.0 m~43.0 m)
- 33.2' or 58.1' (10.1 m or 17.7 m) bi-fold lattice jib (tilt type) with 3.5°, 25° or 45° pinned offsets and self storing pins.
- Quick reeving type bi-fold jib
- Anti-Two block device (overwind cutout)
- Mirror for main and auxiliary hoists
- Work lights
- Variable speed main hoist with grooved drum, cable follower and 771' of 3/4" cable.
- Variable speed auxiliary hoist with grooved drum, cable follower and 436' of 3/4" cable.
- Drum rotation indicator (audible, visible and thumper type) main and auxiliary hoist
- Auxiliary lifting sheave (single top) stowable
- 6.2 ton (5.6 metric ton) hook with swivel
- Tadano twin swing system and 360° positive swing lock
- Positive control
- Hydraulic oil cooler
- 3 way adjustable cloth seat with armrests, high back and seat belt
- Tilt-telescoping steering wheel
- Tinted safety glass and sun visor
- Front windshield wiper and washer
- Roof window wiper and washer
- Power window (cab door)
- Cigarette lighter and ashtray
- Cab floor mat
- Pump disconnect in operator's cab
- Air conditioner (hot water heater and cooler)
- Full instrumentation package
- Self centering finger control levers with pilot control
- Control pedals for boom elevating and boom telescoping
- Low oil pressure/high water temp. warning device (visual)
- Rear steer centering light
- Air cleaner dust indicator
- Tadano electronic load moment indicator system (AML-C)
- Boom angle indicator
- Outrigger extension length detector
- Electronic crane monitoring system
- Rear view mirrors (right and left side)
- Fenders
- Air dryer
- Complete highway light package
- Towing hooks-Front and rear
- Hook block tie down (front bumper)
- Weighted hook storage compartment
- Halogen head lamp
- Independently controlled outriggers
- Four outrigger extension positions
- Self-storing outrigger pads
- Electronic controlled automatic transmission driven by torque converter
- 4 X 4 X 4 drive/steer
- Non-spin rear differential
- Automatic rear axle oscillation lockout system
- 29.5-25 22PR (OR) tires or 29.5-25 28PR (OR) tires
- Disc brakes
- Water separator with filter(high filtration)
- Back-up alarm
- 24 volt electric system
- Tool storage compartment
- Tire inflation kit
- Mitsubishi 6M60-TLA3B turbo charged after cooled engine (267HP) with exhaust brake
- Engine over-run alarm
- Lifting eyes
- Fuel consumption monitor
- Eco mode system

OPTIONAL EQUIPMENT

- 68.0 metric ton (75 Ton) - 7 sheave with swivel hook and safety latch for 19mm(3/4") wire rope
- 35.0 metric ton (38.6 Ton) - 3 sheave with swivel hook and safety latch for 19mm(3/4") wire rope
- Working lamp with remote controller
- Telematics(machine data logging and monitoring system) with HELLO-NET via internet (availability depends on countries)

HOISTING PERFORMANCE

LINE SPEEDS AND PULLS

Layer	Main or auxiliary hoist - 0.4m (15-3/4") drum			
	Line speeds ¹		Line pulls Available ²	
	m/min	F.P.M	kgf	Lbs.
1st	109	358	6,880	15,200
2nd	118	387	6,310	13,900
3rd	127	417	5,820	12,800
4th	136	446	5,410	11,900
5th	144	475	5,050	11,100
6th	153	504	4,730	10,400
7th ³	162	533	4,460	9,800

- Maximum permissible line pull wire strength 7,085kg(15,600lbs) with 6X31 class rope.

¹ Line speeds based only on hook block, not loaded.

² Developed by machinery with each layer of wire rope, but not based on rope strength or other limitation in machinery or equipment.

³ Seventh layer of wire rope are not recommended for hoisting operations.

DRUM WIRE ROPE CAPACITIES

Wire rope layer	Main and auxiliary drum grooved lagging 19mm (3/4") wire rope			
	Rope per layer		Total wire rope	
	Meters	Feet	Meters	Feet
1	37.6	123.3	37.6	123.3
2	40.7	133.5	78.3	256.8
3	43.7	143.3	122.0	400.2
4	46.8	153.5	168.8	553.8
5	49.8	163.3	218.6	717.1
6	53.0	173.8	271.6	891.0
7	55.9	183.3	327.5	1074.4

DRUM DIMENSIONS

	mm	Inch
Root diameter	400	15-3/4"
Length	599	23-9/16"
Flange diameter	695	27-3/8"

GR-750XL WORKING RANGE CHART

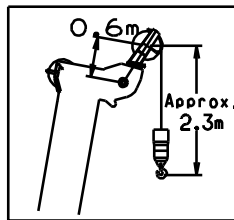
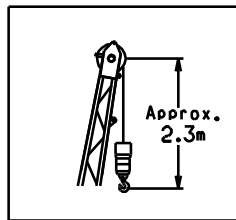
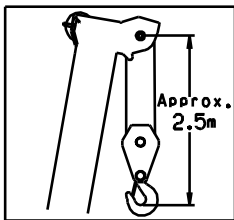
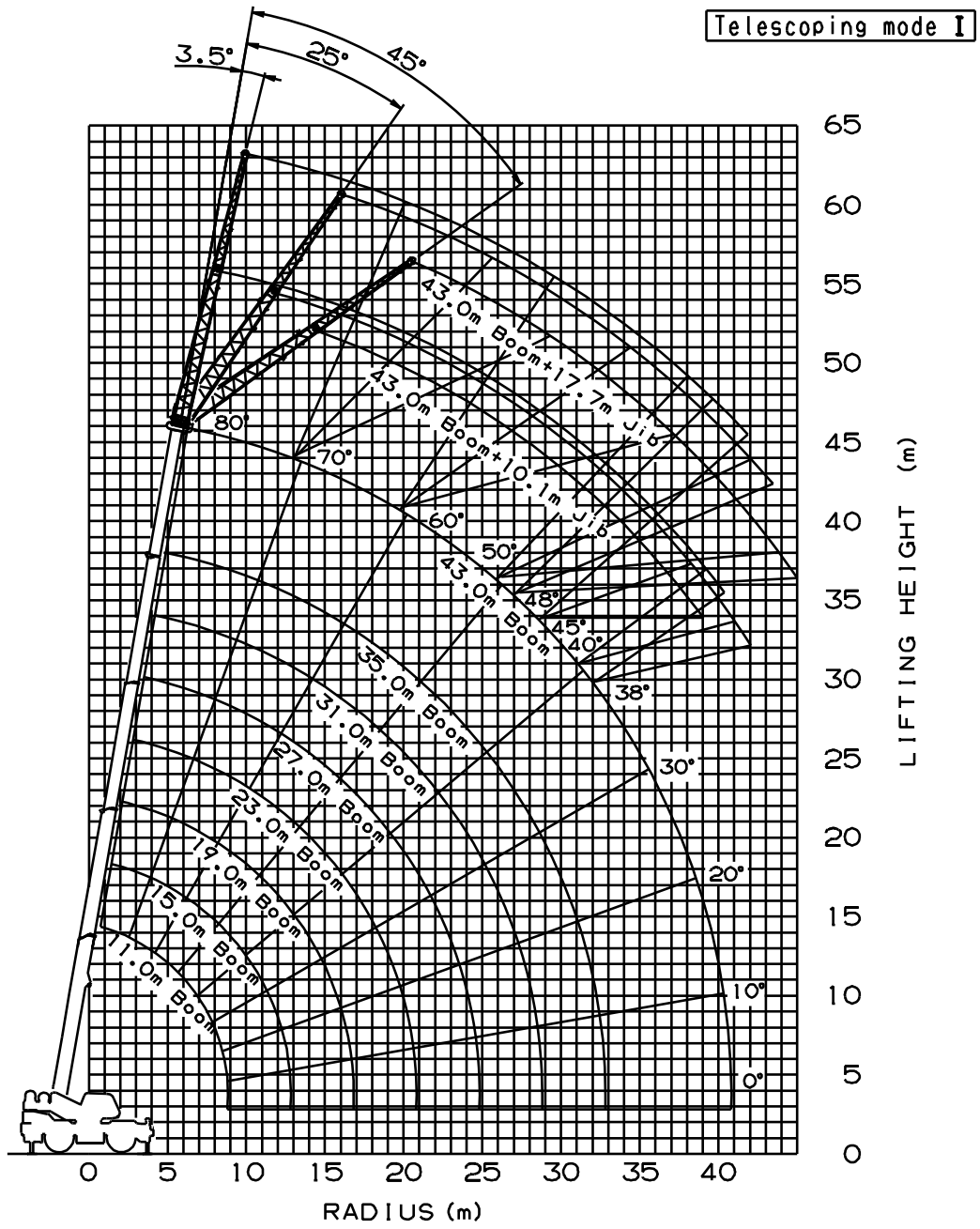

NOTE: 1. Boom and jib geometry shown are for unloaded condition and machine standing level on firm supporting surface.

Boom deflection and subsequent radius and boom angle change must be accounted for when applying load to hook.

Boom Length

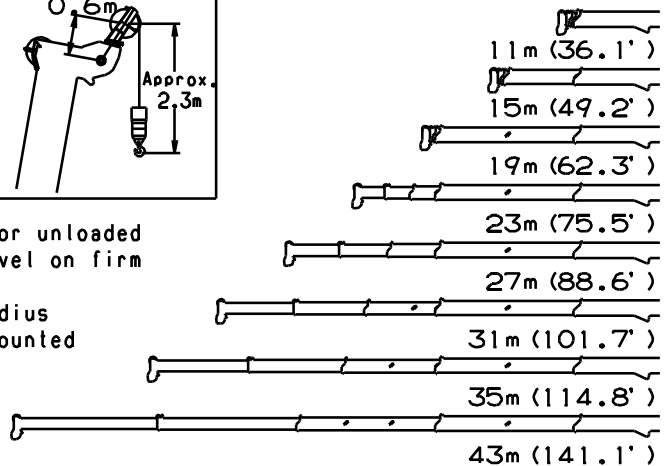

GR-750XL WORKING RANGE CHART

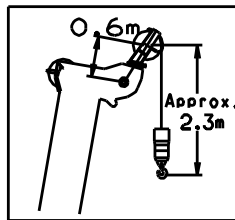
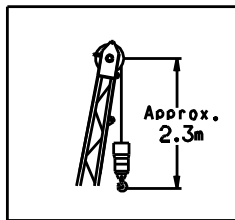
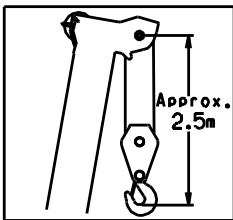
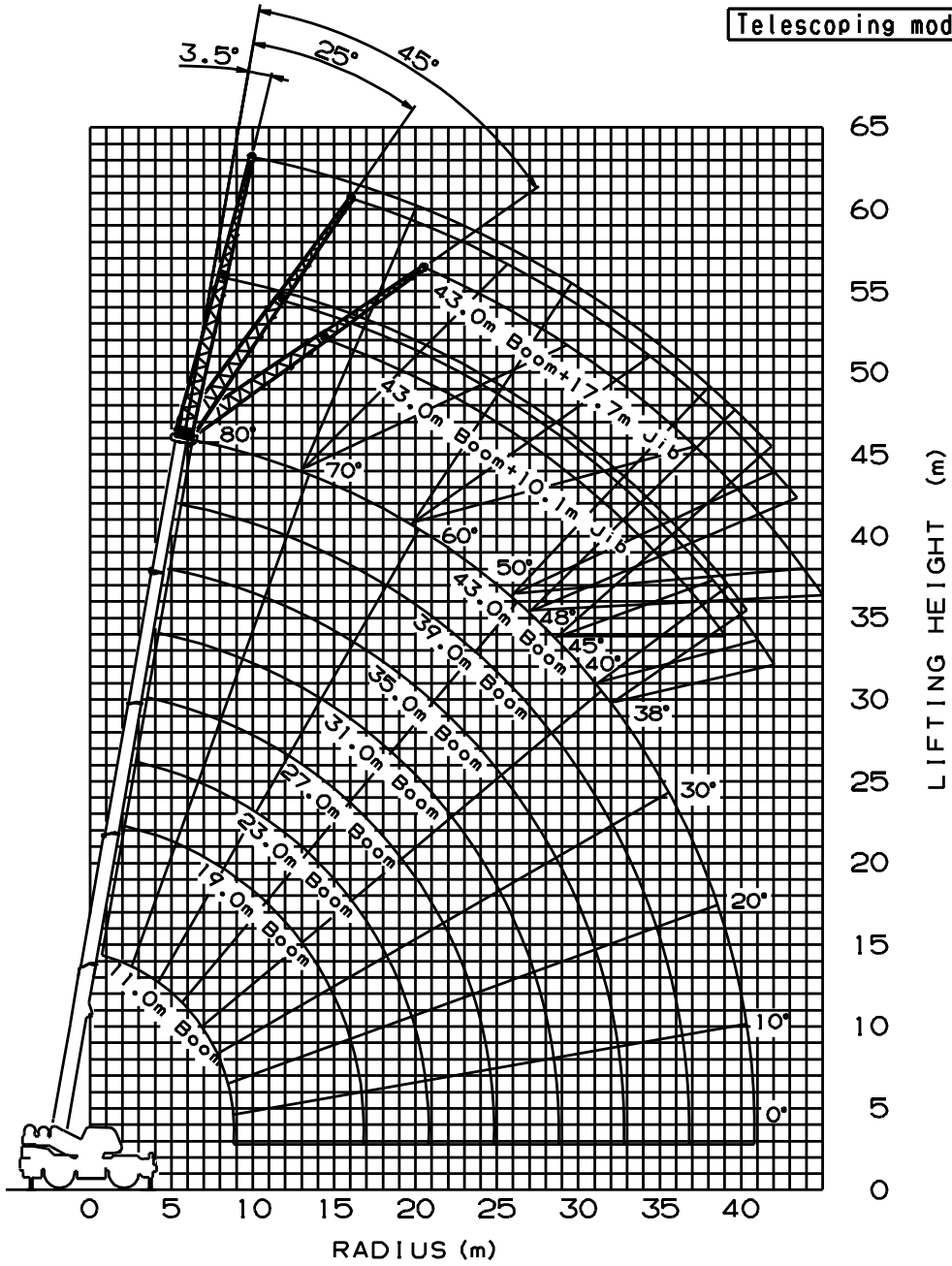

Boom Length

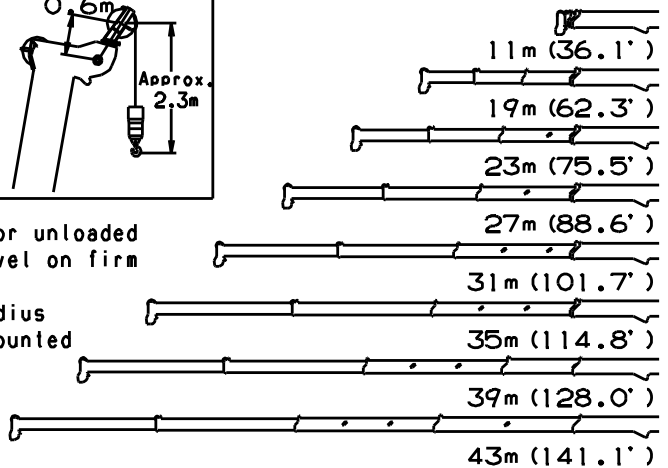

NOTE: 1. Boom and jib geometry shown are for unloaded condition and machine standing level on firm supporting surface. Boom deflection and subsequent radius and boom angle change must be accounted for when applying load to hook.

GR-750XL RATED LIFTING CAPACITIES (IN METRIC TON)

ON OUTRIGGERS FULLY EXTENDED 7.3m(23' 11-3/8") SPREAD 360° ROTATION													
C	43.0m(141.1') Boom + 10.1m(33.2') Jib						C	43.0m(141.1') Boom + 17.7m(58.1') Jib					
	3.5° Tilt		25° Tilt		45° Tilt			3.5° Tilt		25° Tilt		45° Tilt	
	R	W	R	W	R	W		R	W	R	W	R	W
80	10.7	4.2	14.8	4.0	16.9	3.4	80	13.1	2.6	20.0	2.4	23.4	1.8
79	11.8	4.2	15.8	3.9	17.8	3.3	79	14.4	2.6	21.1	2.3	24.4	1.7
78	12.8	4.2	16.7	3.7	18.6	3.2	78	15.6	2.6	22.1	2.2	25.4	1.7
77	13.8	4.2	17.7	3.6	19.6	3.1	77	16.8	2.6	23.1	2.1	26.2	1.7
76	14.9	4.2	18.6	3.5	20.4	3.1	76	17.9	2.6	24.1	2.1	27.2	1.6
75	16.0	4.2	19.5	3.4	21.3	3.0	75	19.1	2.6	25.1	2.0	28.1	1.6
73	18.0	4.1	21.3	3.3	22.9	2.9	73	21.4	2.6	27.1	1.9	29.8	1.5
70	20.7	3.7	23.9	3.0	25.4	2.7	70	24.8	2.5	30.1	1.7	32.3	1.4
68	22.5	3.5	25.6	2.9	26.7	2.6	68	26.8	2.4	32.0	1.6	33.9	1.4
65	25.5	3.3	28.0	2.7	29.0	2.4	65	29.6	2.1	34.5	1.5	36.2	1.3
63	26.6	3.0	29.5	2.6	30.4	2.4	63	31.4	2.0	36.2	1.4	37.7	1.3
60	28.8	2.6	31.6	2.3	32.4	2.2	60	34.1	1.8	38.7	1.3	39.9	1.2
58	30.3	2.3	32.9	2.1	33.7	2.0	58	35.6	1.6	40.2	1.3	41.2	1.2
55	32.4	1.9	34.8	1.7	35.4	1.6	55	37.9	1.3	42.2	1.0	43.0	0.9
53	33.7	1.6	36.0	1.5	36.5	1.4	53	39.4	1.1	43.5	0.9	44.1	0.8
50	35.6	1.3	37.8	1.2	38.1	1.2	50	41.5	0.8	45.3	0.7	45.7	0.6
48	36.8	1.1	38.9	1.1	39.1	1.0	48	42.9	0.7	46.5	0.5	46.7	0.5
45	38.6	0.9	40.4	0.8	40.6	0.8	45	44.9	0.5				
43	39.7	0.8	41.4	0.7									
40	41.3	0.6	42.9	0.6									
38	42.4	0.5	43.8	0.5									

ON OUTRIGGERS FULLY EXTENDED 7.3m(23' 11-3/8") SPREAD 360° ROTATION													
C	39.0m(128.0') Boom(telescoping mode II) + 10.1m(33.2') Jib						C	39.0m(128.0') Boom(telescoping mode II) + 17.7m(58.1') Jib					
	3.5° Tilt		25° Tilt		45° Tilt			3.5° Tilt		25° Tilt		45° Tilt	
	R	W	R	W	R	W		R	W	R	W	R	W
80	9.4	4.6	13.4	4.3	15.7	3.5	80	11.8	2.8	18.5	2.5	22.1	1.8
79	10.4	4.6	14.3	4.2	16.5	3.4	79	13.0	2.8	19.5	2.4	22.9	1.8
78	11.4	4.6	15.1	4.0	17.3	3.3	78	14.0	2.8	20.5	2.3	23.8	1.8
77	12.3	4.6	16.0	3.9	18.1	3.3	77	15.2	2.8	21.4	2.2	24.6	1.7
76	13.2	4.6	16.8	3.8	18.8	3.2	76	16.3	2.8	22.4	2.2	25.4	1.7
75	14.2	4.6	17.7	3.7	19.5	3.1	75	17.3	2.8	23.2	2.1	26.2	1.6
73	16.0	4.5	19.3	3.5	21.0	3.0	73	19.6	2.8	25.1	2.0	27.8	1.6
70	18.5	4.1	21.6	3.2	23.3	2.8	70	22.6	2.7	27.8	1.8	30.1	1.5
68	20.1	3.9	23.2	3.1	24.6	2.7	68	24.4	2.5	29.4	1.7	31.6	1.4
65	22.5	3.6	25.4	2.8	26.6	2.5	65	27.0	2.2	31.9	1.6	33.7	1.3
63	24.0	3.4	26.8	2.7	27.9	2.4	63	28.7	2.1	33.4	1.5	35.3	1.3
60	26.3	3.0	28.8	2.5	29.8	2.3	60	31.3	1.9	35.7	1.4	37.4	1.2
58	27.6	2.8	30.2	2.4	31.0	2.2	58	32.8	1.8	37.3	1.3	38.8	1.2
55	29.6	2.5	32.1	2.2	32.8	2.1	55	35.2	1.6	39.4	1.3	40.7	1.1
53	30.9	2.3	33.2	2.1	33.8	2.0	53	36.7	1.5	40.8	1.2	41.9	1.1
50	32.8	2.1	35.0	1.9	35.4	1.9	50	38.8	1.4	42.8	1.1	43.6	1.1
48	34.0	1.9	36.0	1.8	36.3	1.7	48	40.1	1.3	44.0	1.1	44.6	1.0
45	35.6	1.7	37.5	1.5	37.6	1.5	45	41.9	1.1	45.5	0.9	45.7	0.9
43	36.7	1.5	38.4	1.4			43	43.1	0.9	46.5	0.8		
40	38.1	1.3	39.7	1.2			40	44.8	0.8	47.8	0.7		
38	39.1	1.2	40.5	1.1			38	45.8	0.7	48.6	0.6		
35	40.4	1.0	41.6	1.0			35	47.3	0.6	49.6	0.5		
33	41.3	0.9	42.3	0.9			33	48.2	0.5	50.3	0.4		
30	42.4	0.8	43.3	0.8									
25	44.0	0.7	44.6	0.6									
20	45.3	0.6											
15	46.2	0.5											

ON OUTRIGGERS FULLY EXTENDED 7.3m(23' 11-3/8") SPREAD 360° ROTATION													
C	35.0(114.8') Boom(telescoping mode I) + 10.1m(33.2') Jib						C	35m(114.8') Boom(telescoping mode I) + 58.1' (17.7m) Jib					
	3.5° Tilt		25° Tilt		45° Tilt			3.5° Tilt		25° Tilt		45° Tilt	
	R	W	R	W	R	W		R	W	R	W	R	W
80	8.6	5.6	12.3	5.1	14.5	4.0	80	10.7	3.2	17.3	2.8	21.0	2.1
79	9.4	5.6	13.0	4.7	15.1	3.8	79	11.7	3.2	18.1	2.6	21.7	1.9
78	10.3	5.6	13.9	4.7	15.9	3.8	78	12.7	3.2	19.1	2.6	22.5	1.9
77	11.2	5.6	14.7	4.7	16.7	3.7	77	13.7	3.2	20.0	2.6	23.4	1.9
76	12.1	5.6	15.4	4.6	17.3	3.6	76	14.7	3.2	20.9	2.5	24.1	1.9
75	12.9	5.6	16.2	4.5	18.0	3.6	75	15.6	3.2	21.7	2.4	24.9	1.9
73	14.5	5.6	17.7	4.2	19.4	3.4	73	17.6	3.2	23.4	2.3	26.3	1.8
70	16.8	5.2	19.8	3.9	21.4	3.3	70	20.5	3.2	25.8	2.1	28.4	1.7
68	18.3	4.9	21.2	3.7	22.6	3.1	68	22.2	3.1	27.4	2.0	29.8	1.7
65	20.5	4.6	23.2	3.5	24.5	3.0	65	24.7	2.8	29.8	1.9	31.7	1.6
63	21.9	4.4	24.5	3.3	25.7	2.9	63	26.2	2.6	31.1	1.8	33.0	1.5
60	23.9	4.1	26.4	3.1	27.4	2.8	60	28.5	2.4	33.2	1.7	34.8	1.5
58	25.1	3.8	27.6	3.0	28.5	2.7	58	30.0	2.2	34.6	1.6	35.9	1.5
55	26.9	3.2	29.2	2.8	30.1	2.6	55	32.3	2.1	36.5	1.6	37.5	1.4
53	28.1	2.8	30.3	2.5	31.0	2.4	53	33.6	2.0	37.7	1.5	38.5	1.4
50	29.7	2.4	31.9	2.2	32.4	2.1	50	35.5	1.6	39.4	1.4	39.9	1.3
48	30.8	2.2	32.8	2.0	33.2	1.9	48	36.7	1.5	40.4	1.2	40.7	1.2
45	32.3	1.9	34.2	1.7	34.5	1.6	45	38.5	1.2	41.9	1.0	41.9	1.0
43	33.3	1.7	35.0	1.5			43	39.6	1.1	42.8	0.9		
40	34.7	1.5	36.3	1.3			40	41.2	0.9	44.1	0.8		
38	35.6	1.3	37.0	1.2			38	42.2	0.8	44.8	0.7		
35	36.9	1.1	38.1	1.1			35	43.5	0.6	45.9	0.6		
33	37.6	1.0	38.7	1.0			33	44.4	0.6	46.6	0.5		
30	38.7	0.9	39.6	0.8			30	45.6	0.5				
25	40.3	0.7	40.8	0.7									
20	41.5	0.6											
15	42.4	0.5											

C : Loaded boom angle (°)
R : Load radius in meters
W : Rated lifting capacity in metric ton

GR-750XL RATED LIFTING CAPACITIES (IN METRIC TON)

ON OUTRIGGERS MID EXTENDED 6.7m(21' 11-3/4") SPREAD																				
360° ROTATION																				
A B	11(36.1')		15(49.2')		19 (62.3')			23 (75.5')			27 (88.6')			31 (101.7')			35(114.8')		39(128.0')	43(141.1')
	C	C	C	C	C	C	C	C	C	C	C	C	C	C	C	C	C	C	C	C
2.4	72	68.0	77	40.8																
3.0	68	59.7	75	40.8	79	32.0	78	20.0												
3.5	65	53.5	73	40.8	78	32.0	77	20.0	79	20.0	79	20.0								
4.0	62	48.3	71	40.8	76	32.0	75	20.0	78	20.0	78	20.0								
4.5	58	43.6	68	40.8	73	32.0	73	20.0	77	20.0	77	20.0	79	20.0	79	17.0				
5.0	55	40.2	66	38.6	72	31.9	72	20.0	76	20.0	76	20.0	78	19.8	78	16.9				
5.5	52	36.9	64	35.9	71	31.7	71	20.0	75	20.0	75	20.0	77	19.5	77	16.9				
6.0	49	33.6	62	33.3	69	31.6	69	20.0	73	20.0	73	20.0	76	19.3	76	16.8	78	16.6	78	14.4
6.5	44	30.8	60	30.4	68	29.4	67	20.0	72	20.0	72	19.9	75	18.8	75	16.3	77	16.1	77	13.9
7.0	39	28.0	58	27.5	66	26.8	65	20.0	71	20.0	71	19.8	74	18.3	74	15.6	77	15.5	77	13.4
7.5	34	25.3	56	24.6	64	24.1	63	20.0	69	20.0	69	19.7	73	17.8	73	14.9	76	14.8	76	12.9
8.0	29	19.4	53	22.0	63	21.6	62	19.6	68	19.2	68	18.9	72	17.6	72	14.4	75	14.5	75	12.4
9.0			48	17.1	59	16.7	58	18.7	65	17.1	65	17.1	70	17.3	69	13.5	73	14.0	73	11.5
10.0			41	14.0	55	13.6	55	16.0	62	14.3	62	15.4	68	14.8	67	12.5	71	13.5	71	11.0
11.0			33	11.4	50	11.0	50	13.3	59	11.8	59	13.6	65	12.2	65	11.5	69	12.5	69	10.4
12.0			24	9.5	46	9.2	46	11.4	56	9.9	56	11.6	63	10.3	63	10.7	67	10.6	67	9.6
14.0					36	6.5	35	8.6	49	7.2	49	8.8	57	7.6	57	9.0	62	7.8	62	8.4
16.0					20	4.7	19	6.7	42	5.4	42	6.9	52	5.7	52	7.1	58	6.0	58	7.2
18.0									32	4.0	32	5.5	46	4.4	46	5.7	54	4.6	54	5.8
20.0								19	3.0	20	4.5	38	3.4	38	4.6	49	3.6	49	4.7	55
22.0												31	2.6	31	3.8	43	2.8	43	3.9	50
24.0												18	1.9	18	3.2	36	2.2	36	3.2	45
26.0															29	1.6	29	2.7	40	1.8
28.0															17	1.2			34	1.4
30.0																		26	1.0	26
32.0																		15	0.7	15
34.0																				25
36.0																				13
D																				0
																				33

Telescoping conditions (%)

Telescoping mode	I, II	I	I	II	I	II	I	II	I	II	I	II	II	I, II
2nd boom	0	50	100	0	100	0	100	0	100	0	100	0	50	100
3rd boom	0	0	0	33	16	50	33	66	50	83	66	100	100	100
4th boom	0	0	0	33	16	50	33	66	50	83	66	100	100	100
Top boom	0	0	0	33	16	50	33	66	50	83	66	100	100	100

LIFTING CAPACITIES AT ZERO DEGREE BOOM ANGLE ON OUTRIGGERS MID EXTENDED

6.7m(21' 11-3/4") SPREAD 360° ROTATION																										
A C	11(36.1')		15(49.2')		19 (62.3')			23 (75.5')			27 (88.6')			31 (101.7')			35(114.8')		39(128.0')							
	B	B	B	B	B	B	B	B	B	B	B	B	B	B	B	B	B	B	B							
0	8.8	11.9	12.8	7.5	16.9	4.0	16.9	6.0	20.8	2.6	20.9	4.1	24.9	1.7	24.8	2.9	28.7	1.1	28.7	2.1	32.5	0.6	32.5	1.4	36.3	0.7
Telescoping mode	I, II	I	I	II	I	II	I	II	I	II	I	II	I	II	I	II	II	II	II	II	II	II	II	II	II	II

- A : Boom length in meters
- B : Load radius in meters
- C : Loaded boom angle (°)
- D : Minimum boom angle (°) for indicated length (no load)

NOTE: The lifting capacity data stored in the LOAD MOMENT INDICATOR (AML-C) is based on the standard number of parts of line listed in the chart.
Standard number of parts of line for each boom length should be according to the following table.

Boom length in meters (feet)	11 (36.1)	11 to 15 (36.1 to 49.2)	15 to 19 (49.2 to 62.3)	19 to 43 (62.3' to 141.1')	Single top Jib
Telescoping mode	I, II	I	I	II	I, II
Number of parts of line	14	8	6	4	1

GR-750XL RATED LIFTING CAPACITIES (IN METRIC TON)

ON OUTRIGGERS MID EXTENDED 6.7m(21' 11-3/4") SPREAD													
360° ROTATION													
C	43.0m(141.1') Boom + 10.1m(33.2') Jib						C	43.0m(141.1') Boom + 17.7m(58.1') Jib					
	3.5° Tilt		25° Tilt		45° Tilt			3.5° Tilt		25° Tilt		45° Tilt	
	R	W	R	W	R	W		R	W	R	W	R	W
80	10.7	4.2	14.8	4.0	16.9	3.4	80	13.1	2.6	20.0	2.4	23.4	1.8
79	11.8	4.2	15.8	3.9	17.8	3.3	79	14.4	2.6	21.1	2.3	24.4	1.7
78	12.8	4.2	16.7	3.7	18.6	3.2	78	15.6	2.6	22.1	2.2	25.4	1.7
77	13.8	4.2	17.7	3.6	19.6	3.1	77	16.8	2.6	23.1	2.1	26.2	1.7
76	14.9	4.2	18.6	3.5	20.4	3.1	76	17.9	2.6	24.1	2.1	27.2	1.6
75	16.0	4.2	19.5	3.4	21.3	3.0	75	19.1	2.6	25.1	2.0	28.1	1.6
73	18.0	4.1	21.3	3.3	22.9	2.9	73	21.4	2.6	27.1	1.9	29.8	1.5
70	20.7	3.7	23.9	3.0	25.4	2.7	70	24.8	2.5	30.1	1.7	32.3	1.4
68	22.5	3.5	25.6	2.9	26.7	2.6	68	26.8	2.4	32.0	1.6	33.9	1.4
65	24.8	2.8	27.7	2.4	28.8	2.2	65	29.3	1.9	34.3	1.5	36.1	1.3
63	26.2	2.3	29.1	2.0	30.1	1.9	63	30.9	1.6	35.9	1.2	37.5	1.1
60	28.4	1.8	31.1	1.6	32.0	1.5	60	33.3	1.1	38.1	0.9	39.4	0.8
58	29.8	1.5	32.4	1.3	33.2	1.2	58	34.5	0.9	39.4	0.7	40.7	0.6
55	31.9	1.1	34.3	1.0	35.0	0.9	55	37.2	0.6	41.5	0.4	42.5	0.4
53	33.2	0.9	35.6	0.8	36.1	0.7	53	38.6	0.4				
50	35.1	0.6	37.4	0.6	37.7	0.5							
48	36.4	0.5	38.5	0.4	38.8	0.4							

ON OUTRIGGERS MID EXTENDED 6.7m(21' 11-3/4") SPREAD													
360° ROTATION													
C	39.0m(128.0') Boom(telescoping mode II) + 10.1m(33.2') Jib						C	39.0m(128.0') Boom(telescoping mode II) + 17.7m(58.1') Jib					
	3.5° Tilt		25° Tilt		45° Tilt			3.5° Tilt		25° Tilt		45° Tilt	
	R	W	R	W	R	W		R	W	R	W	R	W
80	9.4	4.6	13.4	4.3	15.7	3.5	80	11.8	2.8	18.5	2.5	22.1	1.8
79	10.4	4.6	14.3	4.2	16.5	3.4	79	13.0	2.8	19.5	2.4	22.9	1.8
78	11.4	4.6	15.1	4.0	17.3	3.3	78	14.0	2.8	20.5	2.3	23.8	1.8
77	12.3	4.6	16.0	3.9	18.1	3.3	77	15.2	2.8	21.4	2.2	24.6	1.7
76	13.2	4.6	16.8	3.8	18.8	3.2	76	16.3	2.8	22.4	2.2	25.4	1.7
75	14.2	4.6	17.7	3.7	19.5	3.1	75	17.3	2.8	23.2	2.1	26.2	1.6
73	16.0	4.5	19.3	3.5	21.0	3.0	73	19.6	2.8	25.1	2.0	27.8	1.6
70	18.5	4.1	21.6	3.2	23.3	2.8	70	22.6	2.7	27.8	1.8	30.1	1.5
68	20.1	3.9	23.2	3.1	24.6	2.7	68	24.4	2.5	29.4	1.7	31.6	1.4
65	22.5	3.6	25.4	2.8	26.6	2.5	65	27.0	2.2	31.9	1.6	33.7	1.3
63	24.1	3.4	26.8	2.7	27.9	2.4	63	28.7	2.1	33.4	1.5	35.3	1.3
60	26.1	2.7	28.8	2.4	29.8	2.2	60	31.3	1.9	35.7	1.4	37.4	1.2
58	27.4	2.4	30.0	2.1	30.9	2.0	58	32.7	1.6	37.3	1.3	38.8	1.2
55	29.4	1.9	31.8	1.7	32.6	1.6	55	34.8	1.3	39.2	1.0	40.5	0.9
53	30.6	1.7	32.9	1.5	33.7	1.4	53	36.3	1.1	40.4	0.9	41.5	0.8
50	32.4	1.4	34.6	1.2	35.2	1.2	50	38.3	0.8	42.2	0.7	43.0	0.6
48	33.6	1.2	35.6	1.1	36.1	1.0	48	39.6	0.7	43.3	0.5	43.8	0.5
45	35.2	1.0	37.1	0.9	37.5	0.8	45	41.5	0.5	44.9	0.4		
43	36.3	0.8	38.1	0.8			43	42.7	0.4				
40	37.9	0.7	39.5	0.6									
38	38.8	0.5	40.3	0.5									
35	40.2	0.4	41.5	0.4									

ON OUTRIGGERS MID EXTENDED 6.7m(21' 11-3/4") SPREAD													
360° ROTATION													
C	35.0(114.8') Boom(telescoping mode I) + 10.1m(33.2') Jib						C	35m(114.8') Boom(telescoping mode I) + 58.1' (17.7m) Jib					
	3.5° Tilt		25° Tilt		45° Tilt			3.5° Tilt		25° Tilt		45° Tilt	
	R	W	R	W	R	W		R	W	R	W	R	W
80	8.6	5.6	12.3	5.1	14.5	4.0	80	10.7	3.2	17.3	2.8	21.0	2.1
79	9.4	5.6	13.0	4.7	15.1	3.8	79	11.7	3.2	18.1	2.6	21.7	1.9
78	10.3	5.6	13.9	4.7	15.9	3.8	78	12.7	3.2	19.1	2.6	22.5	1.9
77	11.2	5.6	14.7	4.7	16.7	3.7	77	13.7	3.2	20.0	2.6	23.4	1.9
76	12.1	5.6	15.4	4.6	17.3	3.6	76	14.7	3.2	20.9	2.5	24.1	1.9
75	12.9	5.6	16.2	4.5	18.0	3.6	75	15.6	3.2	21.7	2.4	24.9	1.9
73	14.5	5.6	17.7	4.2	19.4	3.4	73	17.6	3.2	23.4	2.3	26.3	1.8
70	16.8	5.2	19.8	3.9	21.4	3.3	70	20.5	3.2	25.8	2.1	28.4	1.7
68	18.3	4.9	21.2	3.7	22.6	3.1	68	22.2	3.1	27.4	2.0	29.8	1.7
65	20.4	4.5	23.2	3.5	24.5	3.0	65	24.7	2.8	29.8	1.9	31.7	1.6
63	21.7	3.8	24.5	3.2	25.7	2.9	63	26.2	2.6	31.1	1.8	33.0	1.5
60	23.6	3.1	26.2	2.7	27.3	2.5	60	28.4	2.1	33.2	1.7	34.8	1.5
58	24.8	2.7	27.3	2.3	28.3	2.2	58	29.8	1.8	34.4	1.5	35.8	1.3
55	26.6	2.2	29.0	1.9	29.9	1.8	55	31.8	1.4	36.3	1.2	37.4	1.0
53	27.7	1.9	30.1	1.7	30.8	1.6	53	33.1	1.2	37.4	1.0	38.4	0.9
50	29.4	1.6	31.6	1.4	32.2	1.3	50	35.0	0.9	39.1	0.8	39.7	0.7
48	30.5	1.4	32.6	1.2	33.0	1.1	48	36.3	0.8	40.1	0.6	40.7	0.6
45	32.1	1.1	34.0	1.0	34.3	0.9	45	38.1	0.6	41.6	0.4	41.9	0.4
43	33.1	0.9	34.8	0.8			43	39.2	0.4				
40	34.5	0.7	36.1	0.7									
38	35.4	0.6	36.9	0.5									
35	36.7	0.5	37.9	0.4									

C :Loaded boom angle (°)
R :Load radius in meters
W :Rated lifting capacity in metric ton

GR-750XL RATED LIFTING CAPACITIES (IN METRIC TON)

ON OUTRIGGERS MID EXTENDED 5.5m(18' 1/2") SPREAD																													
360° ROTATION																													
B \ A	11(36.1')		15(49.2')		19 (62.3')			23 (75.5')			27 (88.6')			31 (101.7')			35(114.8')		39(128.0')	43(141.1')									
	C	C	C	C	C	C	C	C	C	C	C	C	C	C	C	C	C	C											
2.4	72	68.0	77	40.8																									
3.0	68	56.0	75	40.8	79	32.0	78	20.0																					
3.5	65	49.6	73	40.8	78	32.0	77	20.0	79	20.0	79	20.0																	
4.0	62	44.6	71	40.2	76	32.0	75	20.0	78	20.0	78	20.0																	
4.5	58	40.1	68	39.4	73	32.0	73	20.0	77	20.0	77	20.0	79	20.0	79	17.0													
5.0	55	36.1	66	35.9	72	30.5	72	20.0	76	20.0	76	20.0	78	19.8	78	16.9													
5.5	52	32.3	64	31.9	71	28.9	71	20.0	75	20.0	75	20.0	77	19.5	77	16.9													
6.0	49	28.4	62	28.0	69	27.2	69	20.0	73	20.0	73	20.0	76	19.3	76	16.8	78	16.6	78	14.4									
6.5	44	25.0	60	24.6	68	24.2	67	19.9	72	19.4	72	19.9	75	18.8	75	16.3	77	16.1	77	13.9									
7.0	39	21.7	57	21.3	66	21.0	65	19.7	71	18.7	71	19.8	74	18.3	74	15.6	77	15.5	77	13.4									
7.5	34	18.3	55	18.0	64	17.7	63	19.5	69	17.9	69	19.7	73	17.8	73	14.9	76	14.8	76	12.9	78	12.9	78	11.2	79	10.0			
8.0	29	15.7	52	15.8	63	15.6	62	18.1	68	16.4	68	18.3	72	16.5	72	14.4	75	14.3	75	12.4	77	12.7	77	10.9	79	10.0			
9.0			47	12.4	59	12.1	58	14.5	65	13.0	65	14.8	69	13.4	69	13.5	73	13.4	73	11.5	75	12.0	75	10.2	77	10.0	79	9.0	
10.0			40	10.1	55	9.8	55	12.0	62	10.6	62	12.4	67	11.1	67	12.1	71	11.4	71	11.0	74	10.9	74	9.5	76	9.6	78	8.7	
11.0			32	8.2	50	7.9	50	10.1	59	8.7	59	10.4	65	9.1	65	10.6	69	9.4	69	10.3	72	9.6	72	9.0	75	9.1	77	8.3	
12.0			23	6.7	46	6.5	46	8.5	56	7.2	56	8.8	63	7.7	63	9.1	67	8.0	67	9.1	70	8.2	70	8.6	73	8.6	75	7.9	
14.0					36	4.4	36	6.4	49	5.1	49	6.7	57	5.5	57	6.8	62	5.8	62	7.0	66	6.0	66	7.1	70	6.7	73	6.2	
16.0					21	3.0	20	4.9	42	3.6	42	5.2	52	4.0	52	5.3	58	4.3	58	5.4	63	4.5	63	5.5	67	5.2	70	4.8	
18.0									32	2.5	32	4.0	46	2.9	45	4.2	53	3.2	53	4.3	59	3.4	59	4.4	63	4.0	66	3.7	
20.0									20	1.7	20	3.2	38	2.1	38	3.3	48	2.4	48	3.4	55	2.6	55	3.5	60	3.2	63	2.8	
22.0													31	1.5	30	2.7	42	1.7	42	2.8	50	1.9	50	2.8	56	2.5	60	2.2	
24.0													18	0.9	18	2.1	35	1.2	35	2.2	45	1.4	45	2.3	51	1.9	57	1.6	
26.0																	28	0.7	29	1.8	40	0.9	40	1.8	47	1.5	53	1.2	
28.0																								34	1.5	43	1.1	49	0.8
30.0																								26	1.2	37	0.8		
32.0																								15	0.9				
D																	21		0		24		0		32		45		
Telescoping conditions (%)																													
Telescoping mode	I, II	I	I	II	I	II	I	II	I	II	I	II	I	II	I	II	I	II	II	I, II									
2nd boom	0	50	100	0	100	0	100	0	100	0	100	0	100	0	100	0	100	0	50	100									
3rd boom	0	0	0	33	16	50	33	66	50	83	66	100	100	100															
4th boom	0	0	0	33	16	50	33	66	50	83	66	100	100	100															
Top boom	0	0	0	33	16	50	33	66	50	83	66	100	100	100															

LIFTING CAPACITIES AT ZERO DEGREE BOOM ANGLE ON OUTRIGGERS MID EXTENDED																												
5.5m(18' 1/2") SPREAD 360° ROTATION																												
C \ A	11(36.1')		15(49.2')		19 (62.3')			23 (75.5')			27 (88.6')			31 (101.7')			35(114.8')		39(128.0')	43(141.1')								
	B	B	B	B	B	B	B	B	B	B	B	B	B	B	B	B	B	B										
0	8.8	11.7	12.8	5.7	16.9	2.5	16.9	4.4	20.9	1.4	20.9	2.9	24.9	0.8	24.8	2.0		28.7	1.3		32.5	0.7						
Telescoping mode	I, II	I	I	II	I	II	I	II	I	II	I	II	I	II	I	II	I	II	II	I, II								

- A** : Boom length in meters
- B** : Load radius in meters
- C** : Loaded boom angle (°)
- D** : Minimum boom angle (°) for indicated length (no load)

NOTE: The lifting capacity data stored in the LOAD MOMENT INDICATOR (AML-C) is based on the standard number of parts of line listed in the chart.
Standard number of parts of line for each boom length should be according to the following table.

Boom length in meters (feet)	11 (36.1)	11 to 15 (36.1 to 49.2)	15 to 19 (49.2 to 62.3)	19 to 43 (62.3' to 141.1')	Single top Jib
Telescoping mode	I, II	I	I	II	I, II
Number of parts of line	14	8	6	4	1

GR-750XL RATED LIFTING CAPACITIES (IN METRIC TON)

ON OUTRIGGERS MID EXTENDED 5.5m(18' 1/2") SPREAD													
360° ROTATION													
C	43.0m(141.1') Boom + 10.1m(33.2') Jib						C	43.0m(141.1') Boom + 17.7m(58.1') Jib					
	3.5° Tilt		25° Tilt		45° Tilt			3.5° Tilt		25° Tilt		45° Tilt	
	R	W	R	W	R	W		R	W	R	W	R	W
80	10.7	4.2	14.8	4.0	16.9	3.4	80	13.1	2.6	20.0	2.4	23.4	1.8
79	11.8	4.2	15.8	3.9	17.8	3.3	79	14.4	2.6	21.1	2.3	24.4	1.7
78	12.8	4.2	16.7	3.7	18.6	3.2	78	15.6	2.6	22.1	2.2	25.4	1.7
77	13.8	4.2	17.7	3.6	19.6	3.1	77	16.8	2.6	23.1	2.1	26.2	1.7
76	14.9	4.2	18.6	3.5	20.4	3.1	76	17.9	2.6	24.1	2.1	27.2	1.6
75	16.0	4.2	19.5	3.4	21.3	3.0	75	19.1	2.6	25.1	2.0	28.1	1.6
73	17.8	3.8	21.2	3.2	22.8	2.8	73	21.3	2.5	27.1	1.9	29.8	1.5
70	20.2	2.8	23.4	2.4	24.9	2.2	70	24.0	1.8	29.5	1.4	32.1	1.2
68	21.8	2.3	24.9	2.0	26.3	1.8	68	25.7	1.4	31.1	1.1	33.4	1.0
65	24.1	1.7	27.7	1.5	28.3	1.4	65	28.2	0.9	33.4	0.7	35.5	0.7
63	25.6	1.4	28.5	1.2	29.6	1.1	63	29.9	0.7	35.0	0.5	37.0	0.5
60	27.9	1.0	30.6	0.9	31.6	0.8	60	32.6	0.5				
58	29.3	0.7	32.0	0.6	32.8	0.6							
55	31.4	0.4											

ON OUTRIGGERS MID EXTENDED 5.5m(18' 1/2") SPREAD													
360° ROTATION													
C	39.0m(128.0') Boom(telescoping mode II) + 10.1m(33.2') Jib						C	39.0m(128.0') Boom(telescoping mode II) + 17.7m(58.1') Jib					
	3.5° Tilt		25° Tilt		45° Tilt			3.5° Tilt		25° Tilt		45° Tilt	
	R	W	R	W	R	W		R	W	R	W	R	W
80	9.4	4.6	13.4	4.3	15.7	3.5	80	11.8	2.8	18.5	2.5	22.1	1.8
79	10.4	4.6	14.3	4.2	16.5	3.4	79	13.0	2.8	19.5	2.4	22.9	1.8
78	11.4	4.6	15.1	4.0	17.3	3.3	78	14.0	2.8	20.5	2.3	23.8	1.8
77	12.3	4.6	16.0	3.9	18.1	3.3	77	15.2	2.8	21.4	2.2	24.6	1.7
76	13.2	4.6	16.8	3.8	18.8	3.2	76	16.3	2.8	22.4	2.2	25.4	1.7
75	14.2	4.6	17.7	3.7	19.5	3.1	75	17.3	2.8	23.2	2.1	26.2	1.6
73	16.0	4.5	19.3	3.5	21.0	3.0	73	19.6	2.8	25.1	2.0	27.8	1.6
70	18.5	4.1	21.6	3.2	23.3	2.8	70	22.6	2.7	27.8	1.8	30.1	1.5
68	20.0	3.5	23.1	2.9	24.6	2.6	68	24.2	2.3	29.4	1.7	31.6	1.4
65	22.1	2.7	25.1	2.3	26.4	2.1	65	26.7	1.8	31.7	1.4	33.6	1.2
63	23.5	2.3	26.4	2.0	27.6	1.8	63	28.2	1.5	33.1	1.2	35.0	1.0
60	25.6	1.8	28.3	1.6	29.4	1.4	60	30.5	1.1	35.1	0.9	36.9	0.8
58	26.9	1.5	29.5	1.3	30.6	1.2	58	32.0	0.9	36.5	0.7	38.1	0.6
55	28.9	1.2	31.3	1.0	32.3	0.9	55	34.2	0.6	38.5	0.5		
53	30.1	1.0	32.5	0.8	33.3	0.8	53	35.7	0.5				
50	32.0	0.7	34.2	0.6	34.8	0.6							
48	33.2	0.5	35.3	0.5	35.8	0.4							

ON OUTRIGGERS MID EXTENDED 5.5m(18' 1/2") SPREAD													
360° ROTATION													
C	35.0(114.8') Boom(telescoping mode I) + 10.1m(33.2') Jib						C	35m(114.8') Boom(telescoping mode I) + 58.1' (17.7m) Jib					
	3.5° Tilt		25° Tilt		45° Tilt			3.5° Tilt		25° Tilt		45° Tilt	
	R	W	R	W	R	W		R	W	R	W	R	W
80	8.6	5.6	12.3	5.1	14.5	4.0	80	10.7	3.2	17.3	2.8	21.0	2.1
79	9.4	5.6	13.0	4.7	15.1	3.8	79	11.7	3.2	18.1	2.6	21.7	1.9
78	10.3	5.6	13.9	4.7	15.9	3.8	78	12.7	3.2	19.1	2.6	22.5	1.9
77	11.2	5.6	14.7	4.7	16.7	3.7	77	13.7	3.2	20.0	2.6	23.4	1.9
76	12.1	5.6	15.4	4.6	17.3	3.6	76	14.7	3.2	20.9	2.5	24.1	1.9
75	12.9	5.6	16.2	4.5	18.0	3.6	75	15.6	3.2	21.7	2.4	24.9	1.9
73	14.5	5.6	17.7	4.2	19.4	3.4	73	17.6	3.2	23.4	2.3	26.3	1.8
70	16.9	4.9	19.8	3.9	21.4	3.3	70	20.5	3.2	25.8	2.1	28.4	1.7
68	18.1	4.1	21.1	3.3	22.6	2.9	68	22.0	2.7	27.4	2.0	29.8	1.7
65	20.1	3.2	22.9	2.6	24.2	2.4	65	24.2	2.1	29.4	1.6	31.5	1.4
63	21.3	2.7	24.1	2.2	25.4	2.0	63	25.7	1.8	30.7	1.3	32.7	1.2
60	23.3	2.1	25.9	1.8	27.0	1.6	60	27.8	1.3	32.7	1.0	34.5	0.9
58	24.5	1.7	27.0	1.5	28.1	1.4	58	29.3	1.0	34.0	0.8	35.6	0.7
55	26.3	1.3	28.7	1.1	29.6	1.1	55	31.4	0.7	35.8	0.6	37.2	0.5
53	27.4	1.1	29.8	0.9	30.6	0.9	53	32.7	0.5				
50	29.1	0.8	31.3	0.7	32.0	0.6							
48	30.2	0.6	32.3	0.5	32.9	0.5							

C :Loaded boom angle (°)
R :Load radius in meters
W :Rated lifting capacity in metric ton

GR-750XL RATED LIFTING CAPACITIES (IN METRIC TON)

ON OUTRIGGERS MIN EXTENDED 2.7m(8' 10-5/16") SPREAD																												
360° ROTATION																												
B \ A	11(36.1')		15(49.2')		19 (62.3')		23 (75.5')		27 (88.6')		31 (101.7')		35(114.8')		39(128.0')		43(141.1')											
	C	C	C	C	C	C	C	C	C	C	C	C	C	C	C	C	C	C										
2.4	72	58.3	77	40.8																								
3.0	68	37.7	74	35.5	79	32.0	78	20.0																				
3.5	65	28.0	73	27.3	77	26.2	77	20.0	79	20.0	79	20.0																
4.0	62	22.1	71	21.5	75	21.1	75	19.4	78	18.8	78	19.5																
4.5	58	17.5	68	17.0	73	16.6	73	18.6	77	17.0	77	18.8	78	17.2	79	17.0												
5.0	55	14.9	66	14.4	72	14.1	72	16.5	76	14.8	76	16.7	78	15.3	78	15.5												
5.5	51	12.6	64	12.2	71	11.9	70	14.2	75	12.6	75	14.4	77	13.0	77	13.9												
6.0	48	10.3	61	10.0	69	9.7	68	11.9	73	10.4	73	12.1	76	10.8	76	12.2	77	10.6	78	11.9								
6.5	43	8.9	59	8.6	67	8.4	67	10.5	72	9.0	72	10.7	75	9.4	75	10.9	77	9.7	77	11.0								
7.0	38	7.8	57	7.5	65	7.2	65	9.3	71	7.9	71	9.5	74	8.3	74	9.7	77	8.5	76	9.8								
7.5	33	6.6	55	6.3	63	6.1	63	8.1	69	6.7	69	8.3	72	7.1	72	8.5	76	7.4	75	8.6	77	7.3	77	8.4	79	7.9		
8.0	29	5.7	52	5.5	62	5.3	62	7.3	68	5.9	68	7.5	71	6.3	71	7.7	75	6.6	74	7.7	77	6.8	77	7.8	79	7.4		
9.0			47	4.1	58	3.9	58	5.8	64	4.5	64	6.1	69	4.9	69	6.2	72	5.2	72	6.3	75	5.3	75	6.4	77	5.9	78	5.4
10.0			40	3.1	54	2.9	54	4.7	61	3.5	61	5.0	67	3.9	67	5.2	70	4.1	70	5.2	73	4.3	73	5.3	75	4.9	77	4.6
11.0			32	2.2	50	2.0	50	3.8	58	2.6	58	4.1	64	3.0	64	4.3	68	3.3	68	4.4	71	3.5	71	4.4	73	4.0	76	3.7
12.0			23	1.5	46	1.3	46	3.1	56	2.0	56	3.4	62	2.3	62	3.6	66	2.6	66	3.7	69	2.8	69	3.7	71	3.3	74	3.0
14.0							35	2.1	48	0.9	49	2.3	57	1.3	56	2.5	62	1.6	61	2.6	65	1.7	65	2.7	69	2.3	71	2.0
16.0							20	1.3			41	1.5			51	1.7			57	1.8	62	1.0	62	1.9	66	1.5	68	1.2
18.0											32	0.9			45	1.1			53	1.2			58	1.3	62	0.9		
20.0															38	0.6			47	0.7			54	0.8				
D			0			38		0		45		21		52		33		58		44		58		51		59		65
Telescoping conditions (%)																												
Telescoping mode	I, II	I	I	II	I	II	I	II	I	II	I	II	I	II	II	I, II												
2nd boom	0	50	100	0	100	0	100	0	100	0	100	0	100	0	100	0	50	100										
3rd boom	0	0	0	33	16	50	33	66	50	83	66	100	100	100	100	100												
4th boom	0	0	0	33	16	50	33	66	50	83	66	100	100	100	100	100												
Top boom	0	0	0	33	16	50	33	66	50	83	66	100	100	100	100	100												

LIFTING CAPACITIES AT ZERO DEGREE BOOM ANGLE ON OUTRIGGERS MIN EXTENDED															
2.7m(8' 10-5/16")SPREAD 360° ROTATION															
C \ A	11(36.1')		15(49.2')		19(62.3')										
	B	B	B	B	B	B									
0	8.8	4.4	12.8	0.9	16.8	1.1									
Telescoping mode	I, II	I			II										

- A : Boom length in meters
- B : Load radius in meters
- C : Loaded boom angle (°)
- D : Minimum boom angle (°) for indicated length (no load)

NOTE: The lifting capacity data stored in the LOAD MOMENT INDICATOR (AML-C) is based on the standard number of parts of line listed in the chart.
 Standard number of parts of line for each boom length should be according to the following table.

Boom length in meters (feet)	11 (36.1)	11 to 15 (36.1 to 49.2)	15 to 19 (49.2 to 62.3)	19 to 43 (62.3' to 141.1')	Single top Jib
Telescoping mode	I, II	I	I	II	I, II
Number of parts of line	14	8	6	4	1

WARNING AND OPERATING INSTRUCTIONS FOR LIFTING CAPACITIES

GENERAL

1. RATED LIFTING CAPACITIES apply only to the machine as originally manufactured and normally equipped by TADANO LTD. Modifications to the machine or use of optional equipment other than that specified can result in a reduction of capacity.
2. Hydraulic cranes can be hazardous if improperly operated or maintained. Operation and maintenance of this machine must be in compliance with information in the **Operation and Maintenance Manual** supplied with the crane. If this manual is missing, order a replacement through the distributor.
3. The operator and other personnel associated with this machine shall fully acquaint themselves with the latest American National Standards Institute (ANSI) safety standards for cranes.

SET UP

1. Rated lifting capacities on the load chart are the maximum allowable crane capacities and are based on the machine standing level on firm supporting surface under ideal job conditions. Depending on the nature of the supporting surface, it may be necessary to have structural supports under the outrigger floats or tires to spread the loads to a larger bearing surface.
2. For outrigger operation, outriggers shall be properly extended with tires free of supporting surface before operating crane.

OPERATION

1. Rated lifting capacities have been tested to and meet minimum requirements of SAE J1063-Cantilevered Boom Crane Structures Method of Test.
2. Rated lifting capacities do not exceed 85 % of the tipping load on outriggers fully extended as determined by SAE J765-Crane Stability Test Code.
Rated lifting capacities for partially extended outriggers are determined from the formula, Rated Lifting Capacities = (Tipping Load - 0.1 x Tip Reaction) / 1.25.
3. Rated lifting capacities above thick lines in the chart are based on crane strength and those below, on its stability. They are based on actual load radius increased by boom deflection.
4. The weight of handling device such as hook blocks, slings, etc., must be considered as part of the load and must be deducted from the lifting capacities.
5. Rated lifting capacities are based on freely suspended loads and make no allowance for such factors as the effect of wind, sudden stopping of loads, supporting surface conditions, inflation of tires, operating speeds, side loads, etc. Side pull on the boom or jib is extremely dangerous. Such action can damage the boom, jib or swing mechanism, and lead to overturning the crane.
6. Rated lifting capacities do not account for wind on lifted load or boom. We recommend against working under the condition that the load is out of control due to a strong wind. During boom lift, consider that the rated lifting capacity is reduced by 50% when the wind speed is 9m/s(20mph) to 12m/s(27mph); reduced by 70% when the wind speed is 12m/s(27mph) to 14m/s(31mph). If the wind speed is 14m/s(31mph) or over, stop operation. During jib lift, stop operation if the wind speed is 9m/s(20mph) or over.
7. Rated lifting capacities at load radius shall not be exceeded. Do not tip the crane to determine allowable loads.
8. Do not operate at boom lengths, radii, or boom angle, where no capacities are shown. Crane may overturn without any load on the hook.
9. When boom length is between values listed, refer to the rated lifting capacities of the next longer and next shorter booms for the same radius. The lesser of the two rated lifting capacities shall be used.

10. When making lifts at a load radius not shown, use the next longer radius to determine allowable capacity.
11. Load per line should not exceed 5,600kg (12,300 lbs.) for main winch and auxiliary winch.
12. Check the actual number of parts of line with LOAD MOMENT INDICATOR (AML-C) before operation. Maximum lifting capacity is restricted by the number of parts of line of LOAD MOMENT INDICATOR (AML-C). Limited capacity is as determined from the formula, Single line pull for main winch 5,600kg(12,300 lbs.) x number of parts of line.
13. The boom angle before loading should be greater to account for deflection. For rated lifting capacities, the loaded boom angle and the load radius is for reference only.
14. The 11.0m (36.1') boom length capacities are based on boom fully retracted. If not fully retracted [less than 15.0m(49') boom length], use the rated lifting capacities for the 15.0m (49') boom length.
15. Extension or retraction of the boom with loads may be attempted within the limits of the RATED LIFTING CAPACITIES. The ability to telescope loads is limited by hydraulic pressure, boom angle, boom length, crane maintenance, etc.
16. For lifting capacity of single top, deduct the weight of the load handling equipment from the rated lifting capacity of the boom. For the lifting capacity of single top, the net capacity shall not exceed 5,600kg (12,300 lbs.) including main boom hook mass attached to the boom.
17. When the base jib or top jib or both jibs are removed, set the jib state switch to the REMOVED position.
18. When erecting and stowing jib, be sure to retain it by hand or by other means to prevent its free movement.
19. Use "ANTI-TWO BLOCK" disable switch when erecting and stowing jib and when stowing hook block. While the switch is pushed, the hoist does not stop, even when overwind condition occurs.
20. For boom length 43.0m(141.1') or less and 35.0m(114.8') or longer with jib, rated lifting capacities are determined by loaded boom angle only in the column headed "43.0m(141.1')boom+jib". For boom length 35.0m(114.8') or less with jib, rated lifting capacities are determined by loaded boom angle only in the column headed "35.0m(114.8')boom+jib". For angles not shown, use the next lower loaded boom angle to determine allowable capacity. (Telescoping MODE For boom length 43.0m(141.1') or less and 39.0m(128.0') or longer with jib, rated lifting capacities are determined by loaded boom angle only in the column headed "43.0m(141.1')boom+jib". For boom length 39.0m(128.0') or less with jib, rated lifting capacities are determined by loaded boom angle only in the column headed "39.0m(128.0')boom+jib". For angles not shown, use the next lower loaded boom angle to determine allowable capacity. (Telescoping MODE
21. When lifting a load by using jib (aux. winch) and boom (main winch) simultaneously, do the following:
 - Enter the operation status as jib operation, not as boom operation.
 - Before starting operation, make sure that mass of load is within rated lifting capacity for jib.
22. Before telescoping the boom, set the telescoping mode selector switch to MODE or MODE with the boom fully retracted. A change of the telescoping mode is not permissible when the boom has been partially or fully extended.
23. Crane operation is prohibited without full counterweight 5.7 ton.(12,600lb) installed. Outriggers shall be extended 7.3m(23'11 3/8) spread when installing or removing removable counterweight.

DEFINITIONS

1. Load Radius: Horizontal distance from a projection of the axis of rotation to supporting surface before loading to the center of the vertical hoist line or tackle with load applied.
2. Loaded Boom Angle: The angle between the boom base section and the horizontal, after lifting the rated lifting capacity at the load radius.
3. Working Area: Area measured in a circular arc about the centerline of rotation.
4. Freely Suspended Load: Load hanging free with no direct external force applied except by the hoist line.
5. Side Load: Horizontal side force applied to the lifted load either on the ground or in the air.

GR-750XL RATED LIFTING CAPACITIES (IN METRIC TON)

ON-RUBBER STATIONARY														
A	Over Front					360° Rotation								
	11(36.1')		19 (62.3')		27 (88.6')	11(36.1')		19 (62.3')		27 (88.6')				
	C	C	C	C	C	C	C	C	C	C				
3.5	65	27.8				65	14.6							
4.0	62	25.5				62	11.6							
4.5	59	23.0				58	9.4							
5.0	56	20.6	72	15.9		55	8.1	72	9.0					
5.5	52	18.3	71	15.9		51	6.9	70	7.8					
6.0	49	15.9	69	15.9		48	5.7	68	6.6					
6.5	44	14.1	67	14.7		43	4.9	67	5.8					
7.0	39	12.5	65	13.2		39	4.2	65	5.1					
7.5	33	10.8	63	11.7		34	3.6	63	4.5					
8.0			62	10.5	72	9.6		62	4.0	71	4.2			
9.0			58	8.5	69	8.7		58	3.1	69	3.3			
10.0			54	7.1	67	7.6		54	2.4	67	2.7			
11.0			50	6.1	64	6.5		50	1.9	64	2.1			
12.0			46	5.2	62	5.6		47	1.4	62	1.7			
14.0			36	3.5	57	4.1								
16.0			20	2.4	52	3.1								
18.0					45	2.4								
20.0					38	1.8								
D	0					0					37		54	
Telescoping conditions (%)														
Telescoping mode	I, II		II		II		I, II		II		II			
2nd boom	0		0		0		0		0		0			
3rd boom	0		33		66		0		33		66			
4th boom	0		33		66		0		33		66			
Top boom	0		33		66		0		33		66			

LIFTING CAPACITIES AT ZERO DEGREE BOOM ANGLE ON-RUBBER STATIONARY											
A	Over Front					360° Rotation					
	11(36.1')		19 (62.3')		27 (88.6')	11(36.1')		19 (62.3')		27 (88.6')	
	B	B	B	B	B	B	B	B	B	B	
0	8.8	7.9	16.9	2.0	24.8	0.4	8.8	2.3			

ON-RUBBER CREEP										
A	Over Front					360° Rotation				
	11(36.1')		19 (62.3')		27 (88.6')	11(36.1')		19 (62.3')		27 (88.6')
	C	C	C	C	C	C	C	C	C	C
3.5	65	20.8								
4.0	62	18.6								
4.5	58	16.6								
5.0	55	15.2	72	15.0						
5.5	52	13.8	70	13.9						
6.0	49	12.5	68	12.9						
6.5	44	11.5	67	12.0						
7.0	39	10.6	65	11.1						
7.5	33	9.7	63	10.2						
8.0			62	9.4	72	9.5				
9.0			58	7.9	69	8.3				
10.0			55	6.7	67	7.1				
11.0			50	5.6	64	6.1				
12.0			46	4.7	62	5.2				
14.0			35	3.2	56	3.9				
16.0			20	2.2	51	2.8				
18.0					45	2.1				
20.0					38	1.5				
D	0					0				
Telescoping conditions (%)										
Telescoping mode	I, II		II		II		I, II		II	
2nd boom	0		0		0		0		0	
3rd boom	0		33		66		0		33	
4th boom	0		33		66		0		33	
Top boom	0		33		66		0		33	

- A : Boom length in meters
- B : Load radius in meters
- C : Loaded boom angle (°)
- D : Minimum boom angle (°) for indicated length (no load)

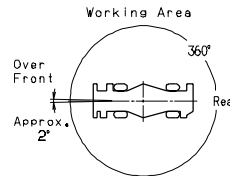

LIFTING CAPACITIES AT ZERO DEGREE BOOM ANGLE ON-RUBBER CREEP											
A	Over Front					360° Rotation					
	11(36.1')		19 (62.3')		27 (88.6')	11(36.1')		19 (62.3')		27 (88.6')	
	B	B	B	B	B	B	B	B	B	B	
0	8.8	7.7	16.9	1.8	24.8	0.4	8.8	2.3			

NOTE: The lifting capacity data stored in the LOAD MOMENT INDICATOR (AML-C) is based on the standard number of parts of line listed in the chart. Standard number of parts of line for on-rubber operation should be according to the following table.

Boom length in meters (feet)	(11m) 36.1'	(11m to 27m) 36.1' to 88.6'	Single top Jib
Number of parts of line	6	4	1

WARNING AND OPERATING INSTRUCTIONS FOR ON-RUBBER LIFTING CAPACITIES

- Rated lifting capacities on-rubber are in pounds and do not exceed 75 % of tipping loads as determined by SAE J765-Crane Stability Test Code.
- Rated lifting capacities shown in the chart are based on condition that crane is set on firm level surfaces with suspension-lock applied. Those above thick lines are based on tire capacity and those below, on crane stability. They are based on actual load radius increased by tire deformation and boom deflection.
- If the suspension-lock cylinders contain air, the axle will not be locked completely and rated lifting capacities may not be obtainable. Bleed the cylinders according to the operation safety and maintenance manual.
- Rated lifting capacities are based on proper tire inflation, capacity and condition. Damaged tires are hazardous to safe operation of crane.
- Tires shall be inflated to correct air pressure.

Tires	Air Pressure
29.5-25 22PR	420 kPa(60 psi)
29.5-25 28PR	450 kPa (64 psi)

- Over front operation shall be performed within 2 degrees in front of chassis.
- On-rubber lifting with "jib" is not permitted. Maximum permissible boom length is 27.0m (88.6 ft.).
- When making lift on-rubber stationary, set parking brake.
- For creep operation, boom must be centered over front of machine, swing lock engaged, and load restrained from swinging. Travel slowly and keep especially avoid any abrupt steering, accelerating or braking.
- Do not operate the crane while carrying the load.
- Creep is motion for crane not to travel more than 60 m (200 ft.) in any 30 minute period and to travel at the speed of less than 1.6km/h (1mph).
- For creep operation, choose the drive mode and proper gear according to the road or working condition.

WARNING AND OPERATING INSTRUCTIONS FOR USING THE LOAD MOMENT INDICATOR (AML-C)

- Set AML select keys in accordance with the actually operating crane conditions and don't fail to make sure, before crane operation, that the displays on front panel are correct.
- When operating crane on outriggers:
 - Set P.T.O. switch to "ON".
 - Press the outrigger state select key to register for the outrigger operation. If the display agrees with the actual state, press the set key to register. After the completion of the registration, the pop-up window closes.
 - Press the lift state select key to register the lift state to be used (single top/jib/boom).
 - Each time the lift state select key is pressed, the display changes. If the display agrees with the actual state, press the set key to register. After the completion of the registration, the pop-up window closes.
 - when erecting and stowing jib, select the status of jib set (Jib lift indicator symbol flickers).
- When operating crane on-rubber:
 - Set P.T.O. switch to "ON".
 - Press the outrigger state select key to register for the on-rubber operation. Each time the outrigger state select key is pressed, the display changes. Select the creep operation, the on-rubber state indicator symbol flickers.
 - Press the lift state select key to register the lift state.

However, pay attention to the following.

- For stationary operation.
 - The front capacities are attainable only when the over front position symbol comes on. When the boom is more than 2 degrees from centered over front of chassis, 360o capacities are in effect.
 - When a load is lifted in the front position and then swung to the side area, make sure the value of the LOAD MOMENT INDICATOR(AML-C) is below the 360o lifting capacity.

- For creep operation.
 - The creep capacities are attainable only when boom is in the straight forward position of chassis and the over front position symbol is on. If boom is not in the straight forward position of chassis , never lift load.
- This machine is equipped with an automatic swing stopping device. (For the details, see Operation and Maintenance Manual.) But, operate very carefully because the automatic swing stop does not work in the following case.
 - During on-rubber operation.
 - When the "P.T.O" switch is set to "OVERRIDE" and the "OVERRIDE" key switch outside the cab is on.
- During crane operation, make sure that the displays on front panel are in accordance with actual operating conditions.
- The displayed values of LOAD MOMENT INDICATOR (AML-C) are based on freely suspended loads and make no allowance for such factors as the effect of wind, sudden stopping of loads, supporting surface conditions, inflation of tire, operating speed, side loads, etc. For safe operation, it is recommended when extending and lowering boom or swinging, lifting loads shall be appropriately reduced.
- LOAD MOMENT INDICATOR (AML-C) is intended as an aid to the operator. Under no condition should it be relied upon to replace use of capacity charts and operating instruction. Sole reliance upon LOAD MOMENT INDICATOR (AML-C) aids in place of good operating practice can cause an accident. The operator must exercise caution to assure safety.

GR-750XL Axle weight distribution chart

	Pounds			Kilograms		
	GVW	Front	Rear	GVW	Front	Rear
Base machine	97,860	50,090	47,770	44,390	22,720	21,670
Remove:						
1. 5.6metric ton(6.2Ton) hook block	-330	-470	140	-150	-214	64
2. 68metric ton(75Ton) hook block	-1,600	-2,800	1,200	-700	-1,244	544
3. Top jib	-740	-805	65	-336	-365	29
4. Base jib	-1,910	-3,270	1,360	-867	-1,483	616
5. Auxiliary lifting sheave	-110	-300	190	-50	-137	87
6. Removable Counterweight (with Auxiliary Winch&wire)	-12,500	5,510	-18,010	-5,670	2,498	-8,168
Add:						
1. 35metric ton(38.6Ton) hook block	+1,000	+1,800	-800	+450	+800	-350

